



U T O P I A P L A N I T I A

# Omicron Light

## USER GUIDE



# OMICRON LIGHT USER GUIDE

The Omicron Light vaporizer is the industry leading, non-flame powered portable extract vaporizer. The original to use pure extract oils with no need for carrier agents or cotton in the cartridge. The patent pending cartridges are an advanced design, that provide voluminous vapor clouds while using very little of your extract oils.

## EXPANDED VIEW

### INCLUDED IN YOUR KIT

- 1 x Omicron Light Vaporizer
- 1 x AC/USB Charger
- 1 x USB Charging Cable
- 1 x Silicone Mouthpiece
- 1 x 2.4  $\Omega$  (Ohm) Extract Cartridge
- 1 x Cartridge Fill Tool
- 1 x Omicron Light Rugged Carrying Case

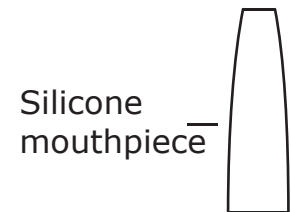

Silicone mouthpiece

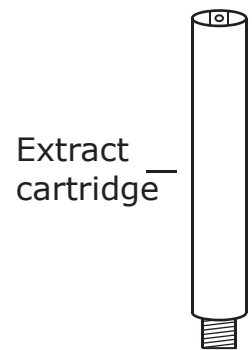

Extract cartridge

### SPECS

- Output voltage is what the internal battery voltage is
- Input voltage: 3.0V – 4.2V
- Output current: 0A – 2.5A
- Quiescent current: <10uA
- Short-circuit protection current: <20mA LED will blink 3 times
- Reverse Current Protection
- Low Voltage Warning, light will blink 3 times when the cell (battery) voltage is under 3.0v
- Durable connector



Base cap

### OMICRON LIGHT SAFETY LOCKOUT

To toggle the lockout feature of the power button on your Omicron Light, quickly press the power button 5 times within 3 seconds until the blue light flashes 3 times. To test the current on/off state, just press the power button once. If the blue light comes on the lockout is deactivated. The safety lockout feature is great to prevent your Omicron Light from accidentally turning on.



**WARNING!!** Cartridges are HOT during and after use. Do Not touch the cartridge until after it has cooled off.



# OMICRON LIGHT USER GUIDE

## CARTRIDGE OXIDIZING INSTRUCTIONS

1. Attach an empty cartridge to your Omicron Light

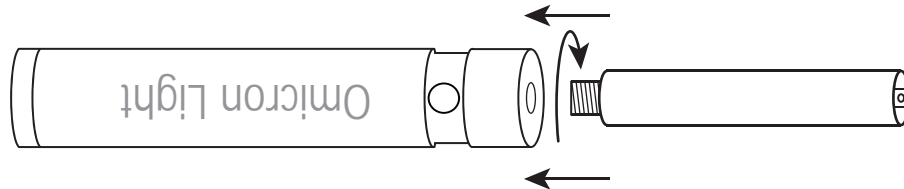

use 1.5, 2.4 or 3.0  $\Omega$  (Ohm) cartridge

2. Hold the Omicron Light on/off button for 3 - 5 seconds then release. During this step, look down the center air tube to ensure element is glowing red at the bottom of air tube ensuring cartridge is good.

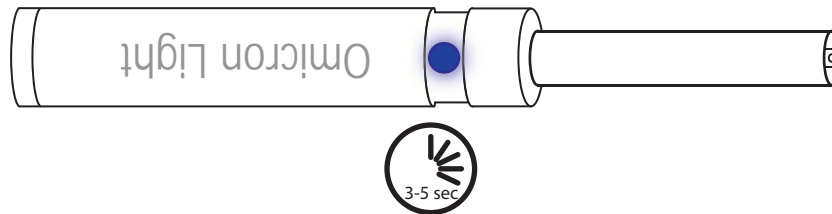

3. Gently blow into cartridge top, allow cooling down for ten seconds.

**Blow into Cartridge Only  
When Empty**

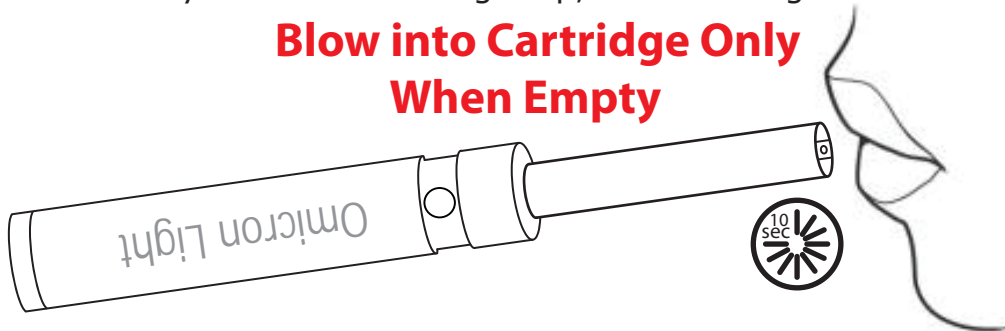

4. Repeat steps 2 and 3 for a minimum of 5 cycles or until the moisture is depleted.



**WARNING!!** Cartridges are HOT during and after use. Do Not touch the cartridge until after it has cooled off.

# OMICRON LIGHT USER GUIDE

## CARTRIDGE FILLING INSTRUCTIONS



### Prerequisites:

- Select a level, flat and smooth heat resistant surface to work on i.e. granite kitchen / bathroom counter
- Jet flame lighter, Heat Shrink Tubing Gun or 1500+ Watt Blow Dryer recommended, regular lighter will also work
- Cartridge Fill Tool

- 1.** Place Fill Tool onto the top of the cartridge. The air tube hole will be covered by the deflector built into the Fill Tool.

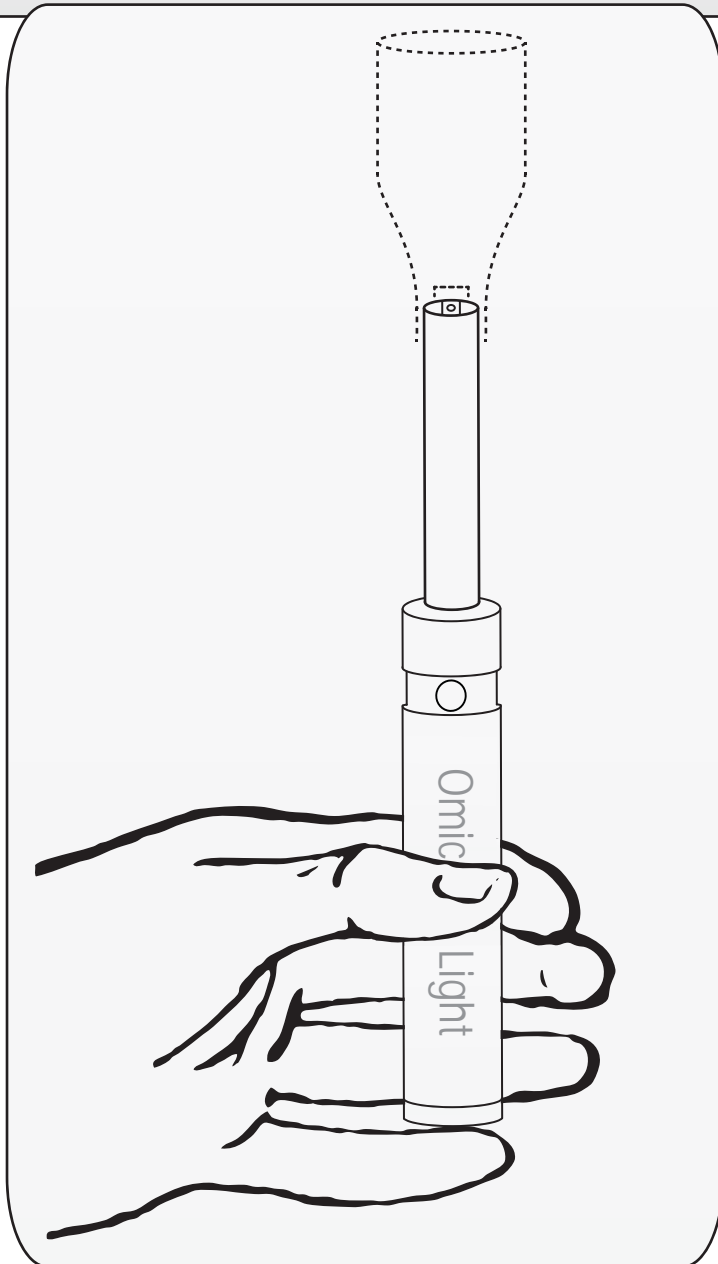

The Fill Tool has been designed for a very tight precise fit onto the top of the cartridge. Some force might be required the first time a new cartridge gets fitted with the Fill Tool.



UTOPIA PLANITIA

# OMICRON LIGHT USER GUIDE

## CARTRIDGE FILLING INSTRUCTIONS

**2.** If your extract is in a vial, place the vial into the Fill Tool upside down and with the vial cap off (2a). If your extract is not in a vial, just load it directly into the Fill Tool (2b). Remember ! **0.5 gram minimum and 1.0 gram maximum.**

**2a.**

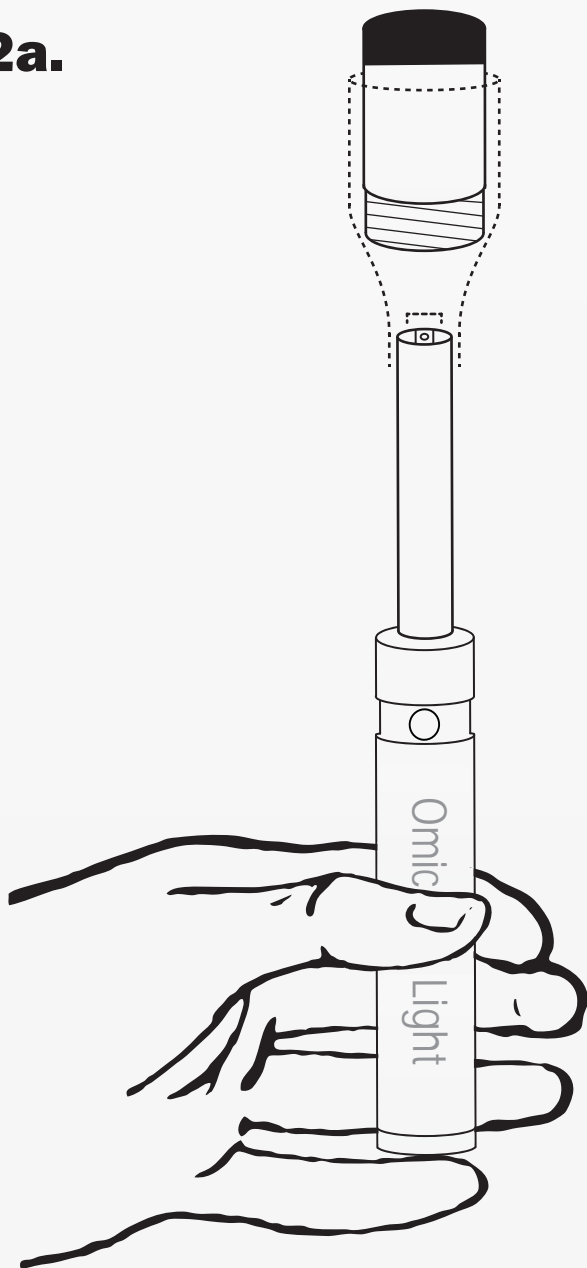

**2b.**

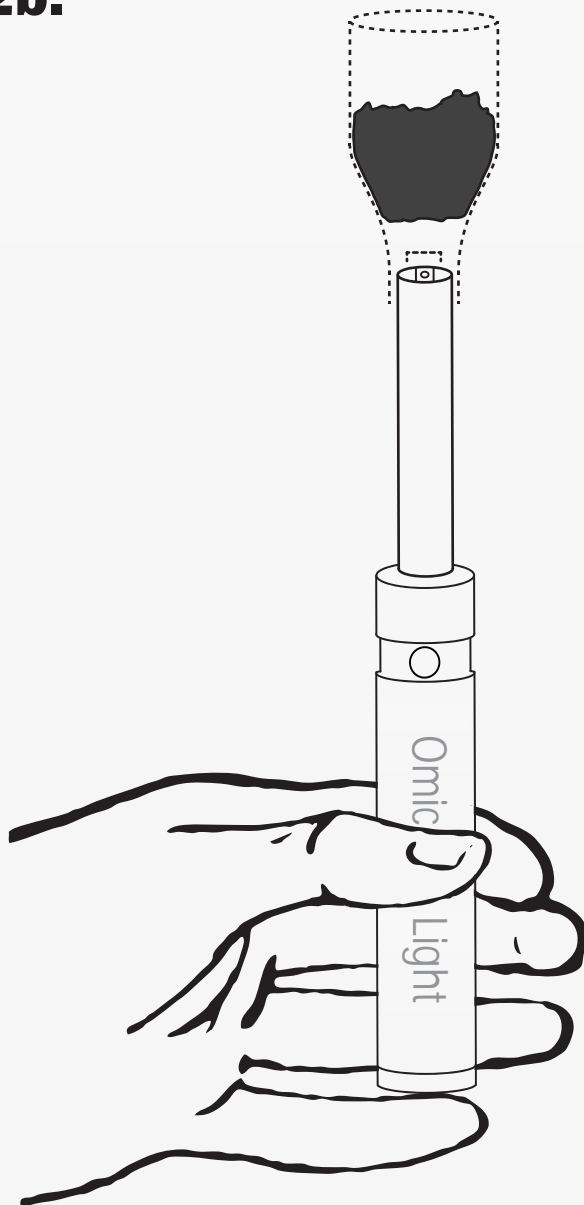





# OMICRON LIGHT USER GUIDE

## CARTRIDGE FILLING INSTRUCTIONS

The goal during cartridge filling is to get all your extract into the bottom of the cartridge using as little heat as possible, but as much as needed. We want to avoid any cold spots on the cartridge walls to help prevent any melted extract from solidifying on the way down and causing an air gap or blockage of any kind.

**\* PRO TIP**

For Optimal Performance Please Use No More Than 0.6 Grams of Oil Per Filling

- 3.** Gently start to apply heat with your blow dryer on a high setting. Preheat the bottom of the cartridge first, just above the threads (1) until you feel the cartridge body get warm. Keep rotating the cartridge so it heats all around evenly. Once you feel the cartridge getting hot, move the blow dryer slowly up the cartridge toward the top (2) being careful to not overheat your extract as this will cause your extract to taste poor. If the cartridge gets much too hot to hold, you are applying too much heat.

**DO NOT overheat the cartridge or your extract!**

**3a.**

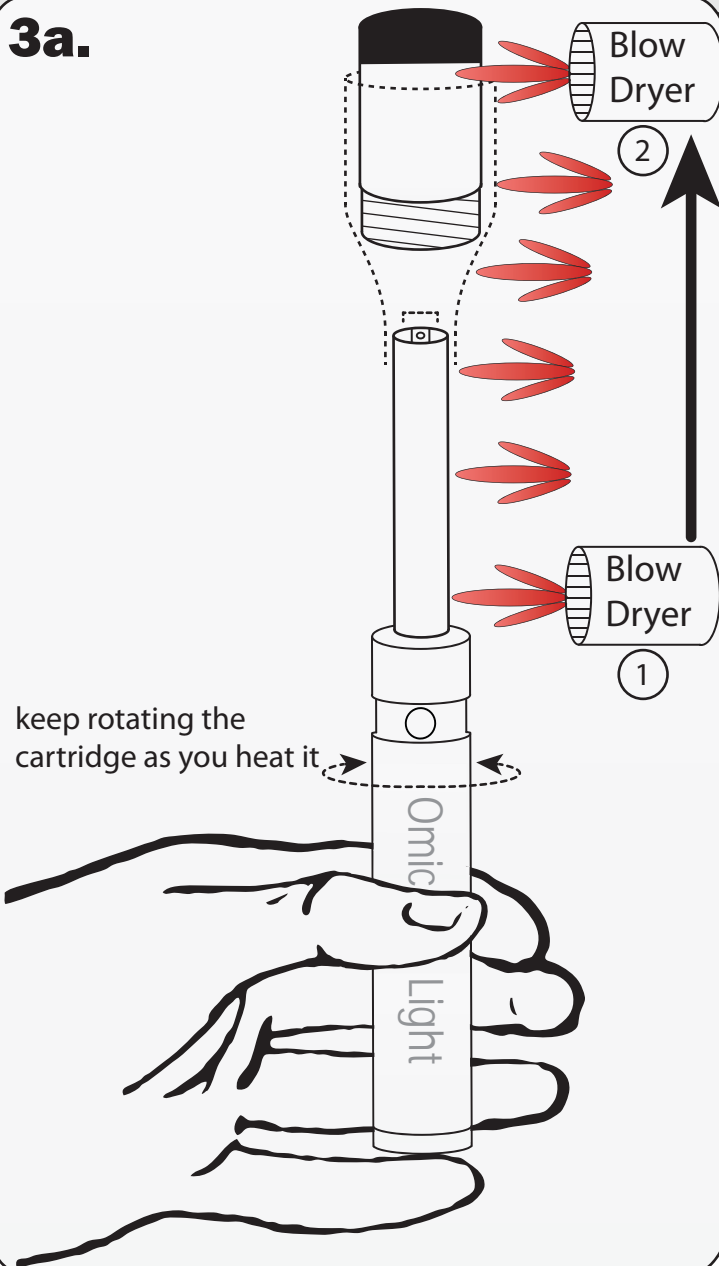

**3b.**

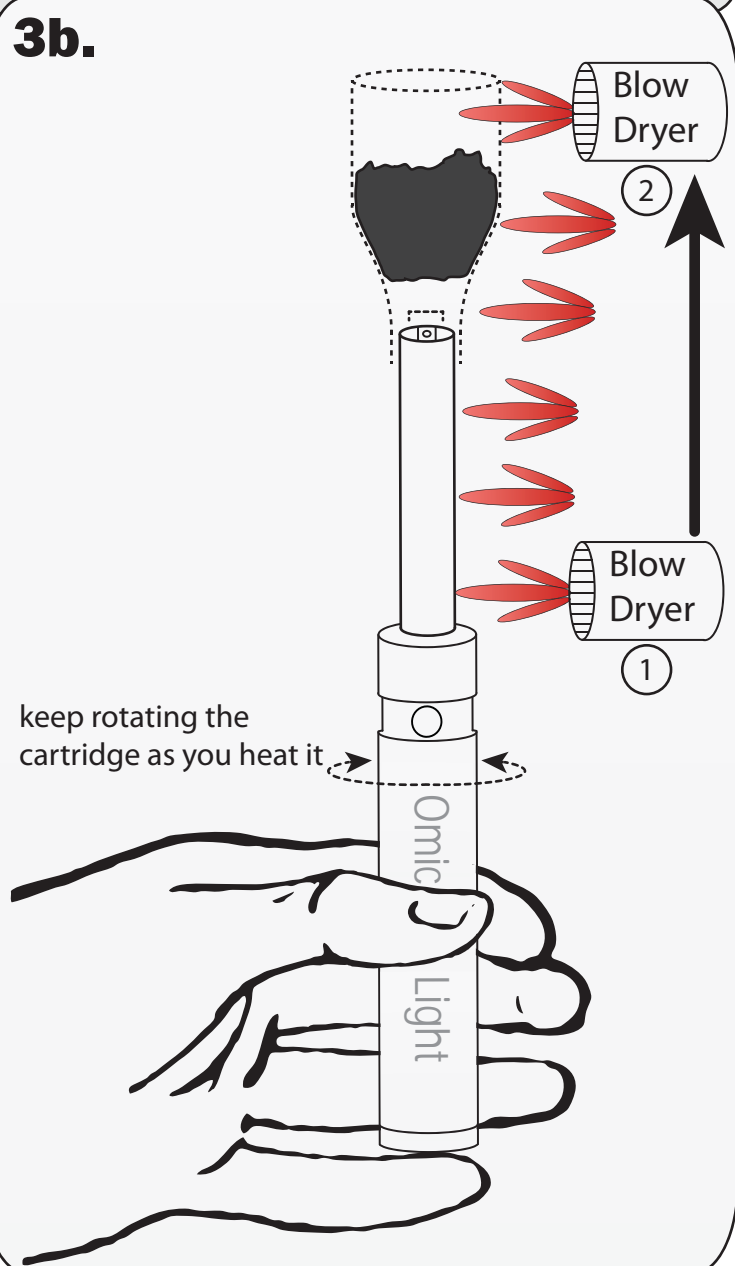



# OMICRON LIGHT USER GUIDE

## CARTRIDGE FILLING INSTRUCTIONS

UTOPIA PLANITIA

- 4.** Keep applying heat with your blow dryer on a high setting, moving the dryer up and down from the top of the vial 4a or Fill Tool 4b down to just above the cartridge threads. Keep rotating the cartridge so it heats all around evenly. You should see your extract start to liquefy and run down the Fill Tool and into the cartridge.

**DO NOT overheat the cartridge or your extract!**

**4a.**

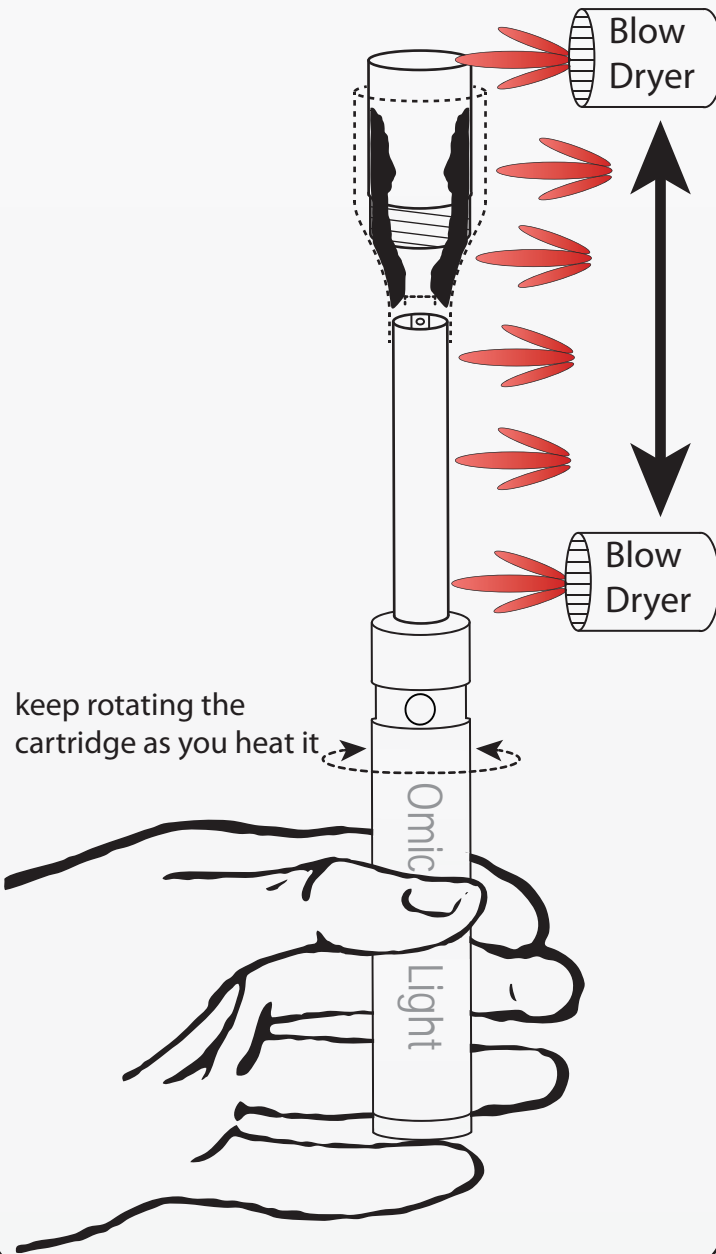

**4b.**

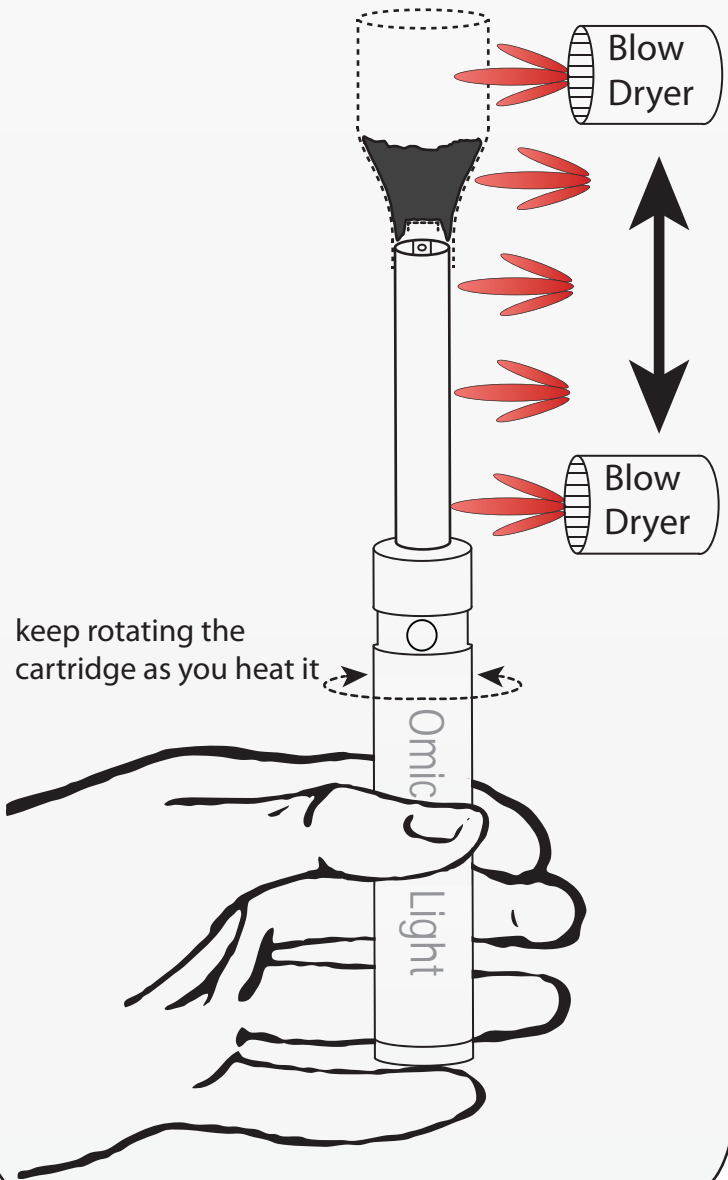



# OMICRON LIGHT USER GUIDE

## CARTRIDGE FILLING INSTRUCTIONS

UTOPIA PLANITIA

- 5.** Once the extract begins to flow into the cartridge, move your blow dryer back down to heat the bottom of the Fill Tool and concentrate heat on all of the cartridge, especially the bottom 2/3rds until all of your extract is in the cartridge. After about 60 - 120 seconds of heating, the extract should be well on its way to the bottom of the cartridge. Let the Fill Tool, vial and cartridge cool down for 5 minutes before touching them!!!

**DO NOT overheat the cartridge or your extract!**

**5a.**

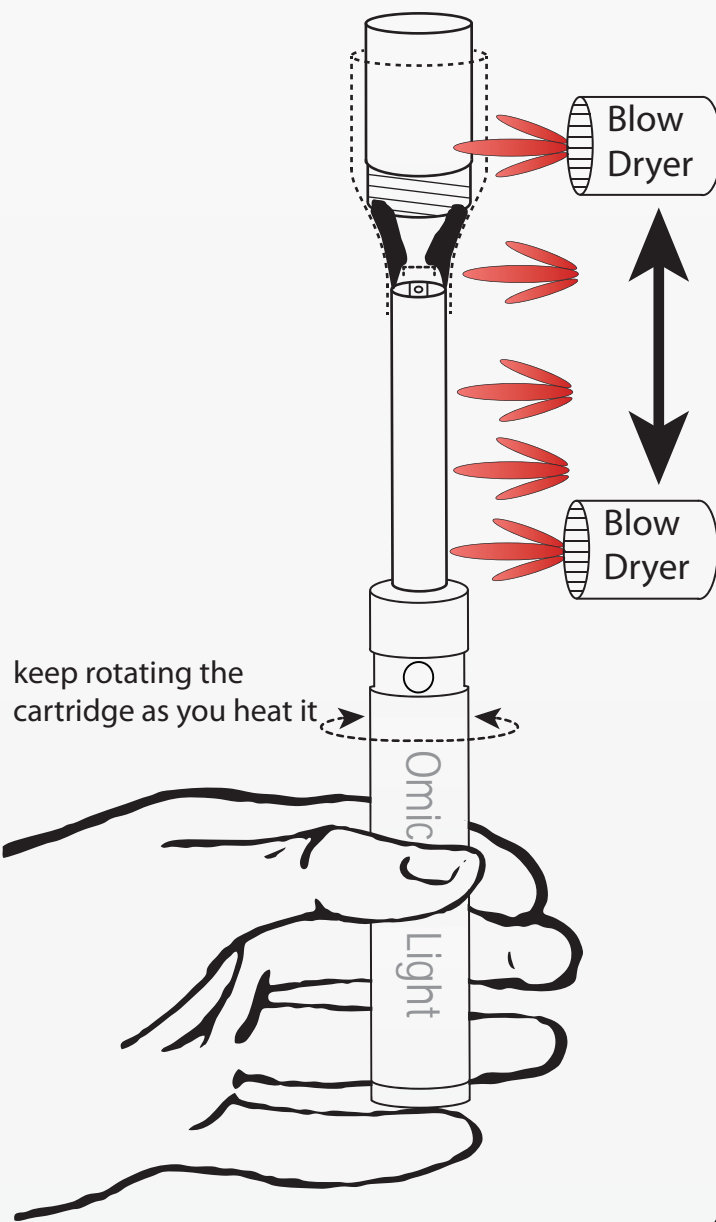

**5b.**

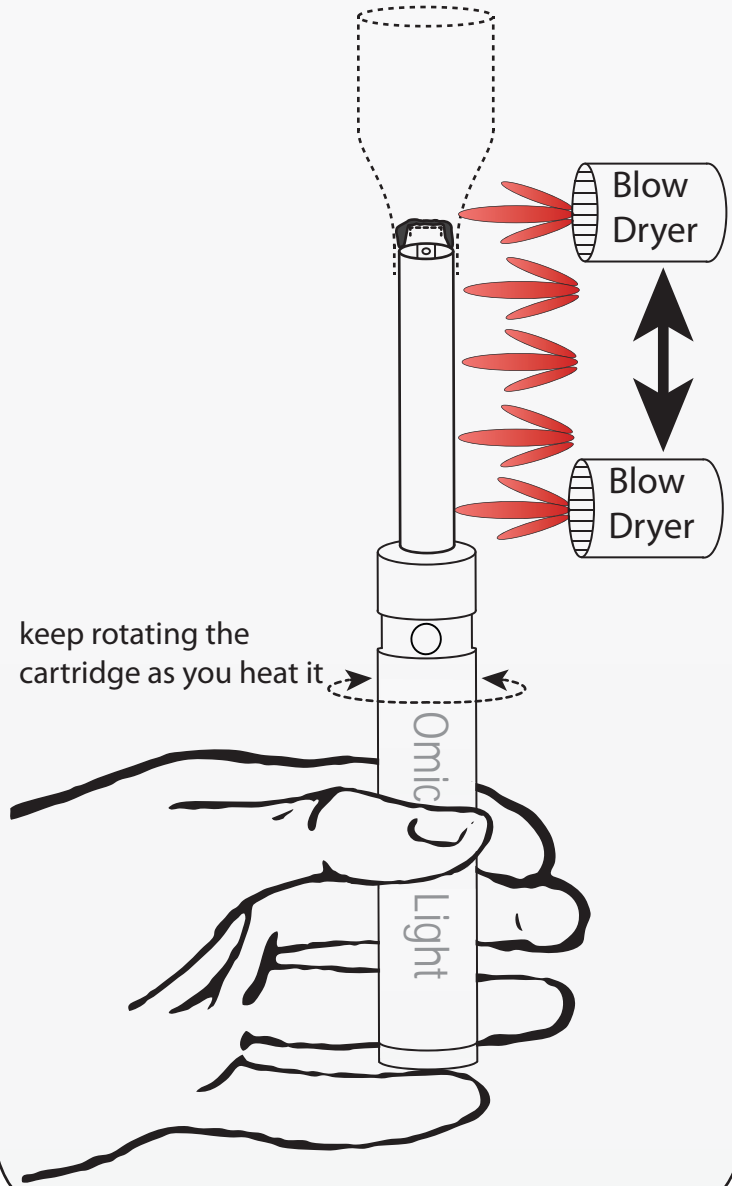





# OMICRON LIGHT USER GUIDE

## CARTRIDGE FILLING INSTRUCTIONS

UTOPIA PLANITIA

- 6.** Once cool, remove the vial (6a) and then the Fill Tool. Place your mouthpiece on the cartridge (6b). The cartridge is now ready for use.

**6a.**

**!!! Let the Fill Tool, vial and cartridge cool down before touching them !!!**

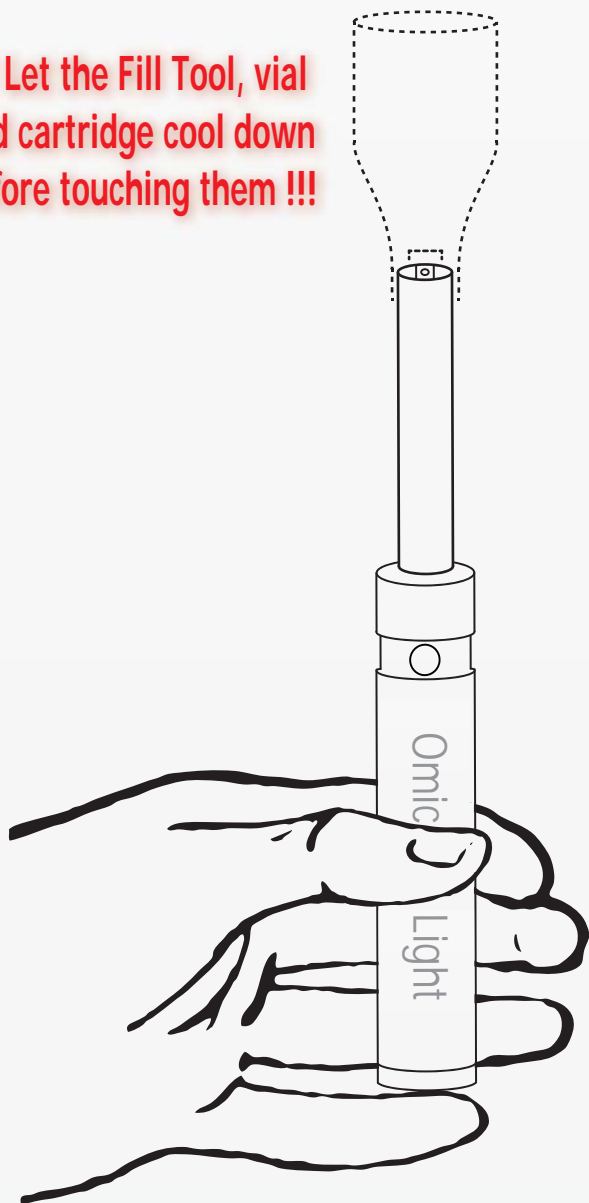

**6b.**

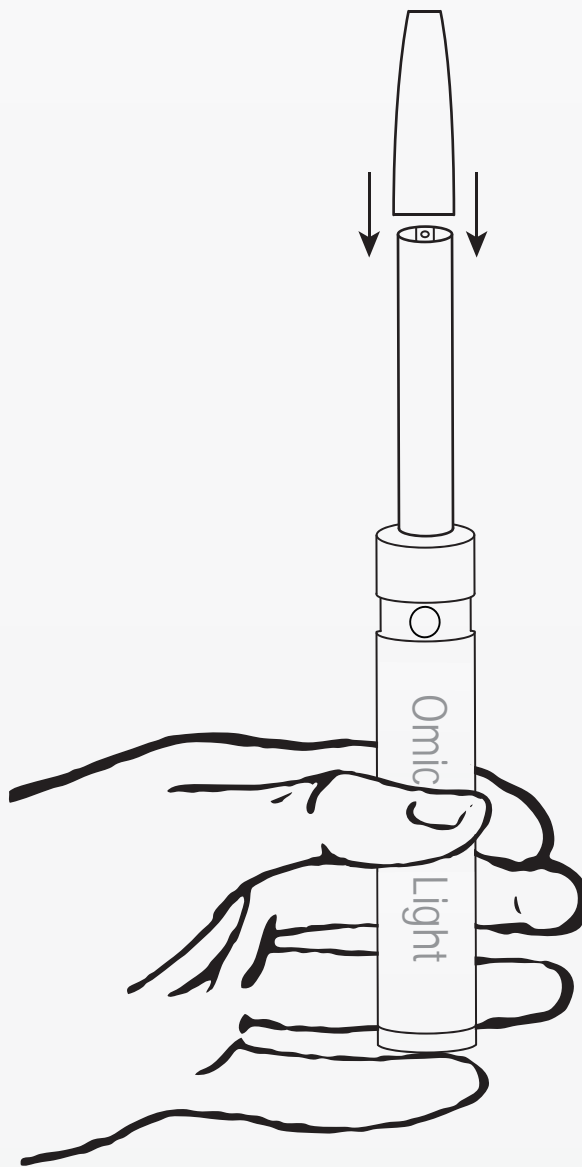



# OMICRON LIGHT USER GUIDE

## CHARGING INSTRUCTIONS

UTOPIA PLANITIA

Omicron Light uses a USB pass-thru charging system. This allows the Omicron Light to be used while charging. The Omicron Light is always powered by its built in lithium ion cell, even while connected to the USB charger.

- 1.** Unscrew the Omicron Light base cap by turning it counter clockwise.

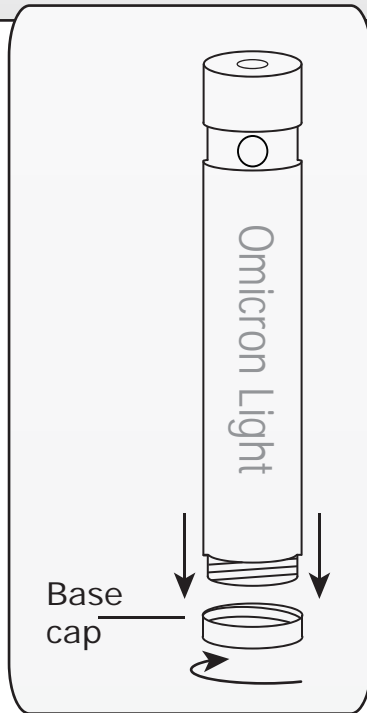

- 2.** Plug the USB cable into the USB port on the bottom of the Omicron Light.

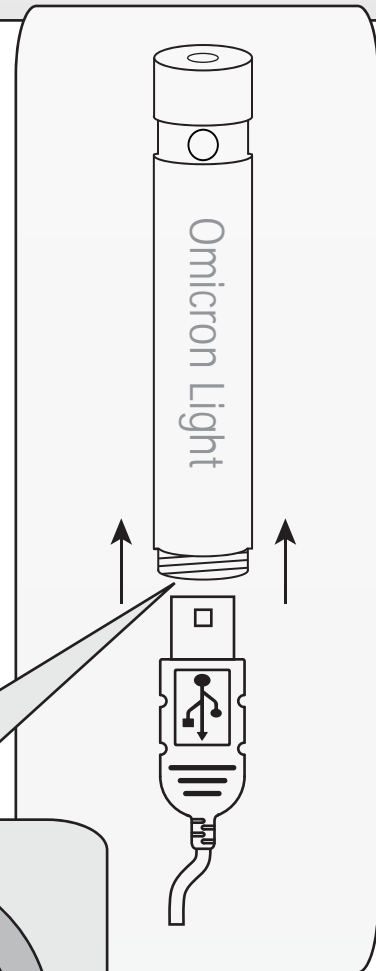

- 3.**

Bottom of Omicron Light

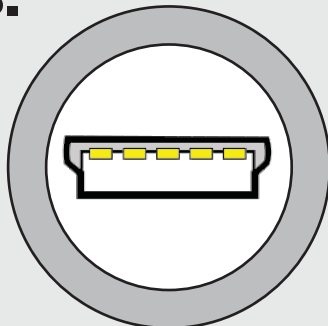

No Red Light on means Omicron Light is not charging or is already charged

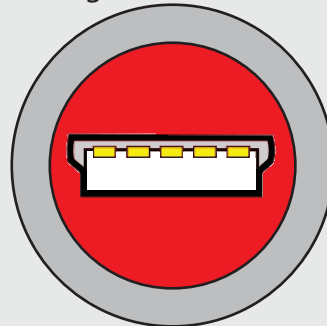

Red Light on means Omicron Light is charging



UTOPIA PLANITIA

# OMICRON LIGHT USER GUIDE

## PRIMING AND USE

**\* PRO TIP**

Keep cartridge standing upright when warm and keep pulling air through it to cool it down faster to prevent clogs and leaks

- Prerequisites:
- Omicron Light
  - Cartridge already filled with no less than .5 grams and no more than 1 gram of extract and attached to your Omicron Light

- 1.** Depending on how long your cartridge has been stored for, the temperature, orientation of it during storage and thickness of your extract, the cartridge may or may not need priming. All newly filled cartridges should be primed before use. To test, place the mouthpiece in your mouth and try to gently suck air through using only your mouth sherlock style, not your lungs, while pressing the button for 2-4 seconds. If you feel and taste vapor, go to step 3. If you did not feel or taste vapor, go to step 2.

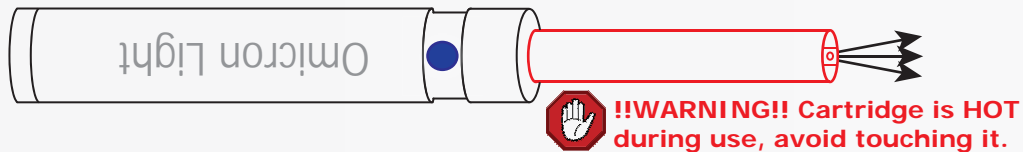

- 2. Priming:** Press and hold the power button on the Omicron Light for 3-5 seconds with 1.5 ohm cartridges and 5-8 seconds with 2.4 ohm cartridges and let go. Immediately try to gently suck air through using only your mouth sherlock style, not your lungs. Keep repeating this cycle until you can feel and taste vapor, sometimes you will hear or feel a tiny pop and then air will start flowing. Never inhale hard using the Omicron Light, this will result in extract being pulled into the air tube causing clogging.

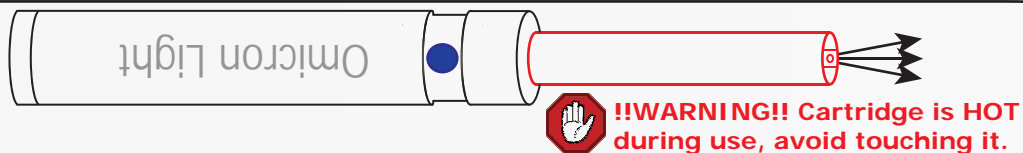

- 3. A.** Using your lungs, very slowly inhale while holding down the power button for no longer than 10 seconds. Some users find it difficult to inhale slowly enough and have greater success using method B.
- B.** Using your mouth, very slowly suck, filling only your mouth with vapor while holding down the power button for a maximum of 6-12 seconds. Remove the Omicron Light from your lips and inhale the vapor in your mouth deeply. For both methods, continue drawing air through the cartridge for 2-3 seconds after releasing the power button to help prevent clogging.
- Always allow the cartridge to cool between hits.**

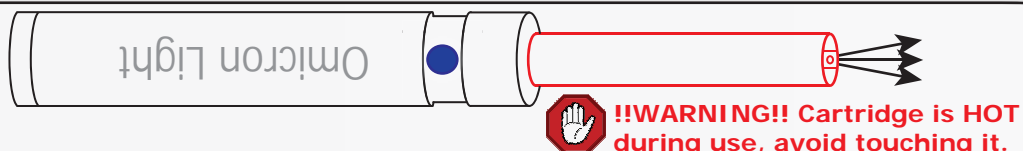

# OMICRON LIGHT USER GUIDE

## FLOW CHART



UTOPIA PLANITIA

Place the mouthpiece in your mouth and try to gently suck air through using only your mouth sherlock style, not your lungs while holding down the power button for 2-6 seconds.

If you feel and taste vapor

**!!!WARNING!!! Cartridge is HOT during use, avoid touching it.**

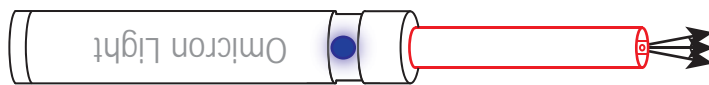

If you did not feel or taste vapor

Press and hold the power button on the Omicron Light for 3-5 seconds for 1.5 ohm cartridges and 5-8 seconds for 2.4 ohm cartridges and let go. Immediately try to gently suck air through using only your mouth sherlock style, not your lungs.

**A. Using your lungs,** very slowly inhale while holding down the power button for no longer than 10 seconds. Some users find it difficult to inhale slowly enough and have greater success using method B.

**B. Using your mouth,** very slowly suck, filling only your mouth with vapor while holding down the power button for a maximum of 6-12 seconds. Remove the Omicron Light from your lips and inhale the vapor in your mouth deeply. For both methods, continue drawing air through the cartridge for 2 - 3 seconds after releasing the power button to help prevent clogging.

**Always allow the cartridge to cool between hits.**

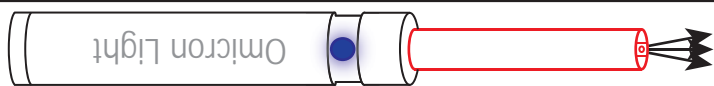

**!!!WARNING!!! Cartridge is HOT during use, avoid touching it.**

Advanced Techniques

Increase the size of your hit by slowly inhaling for no more than 6 seconds. Hold in your hit for 5 seconds while the cartridge cools and repeat until your lungs are full.

**Sherlock Style:** Increase the size of your hit by slowly using your mouth only to inhale the vapors into your mouth for no more than 6 seconds. Release the power button and quickly inhale the vapors that are in your mouth into your lungs and repeat the cycle until your lungs are full. Let the cartridge cool for 5 seconds between hits.

When your session is finished, just sit back and relax!

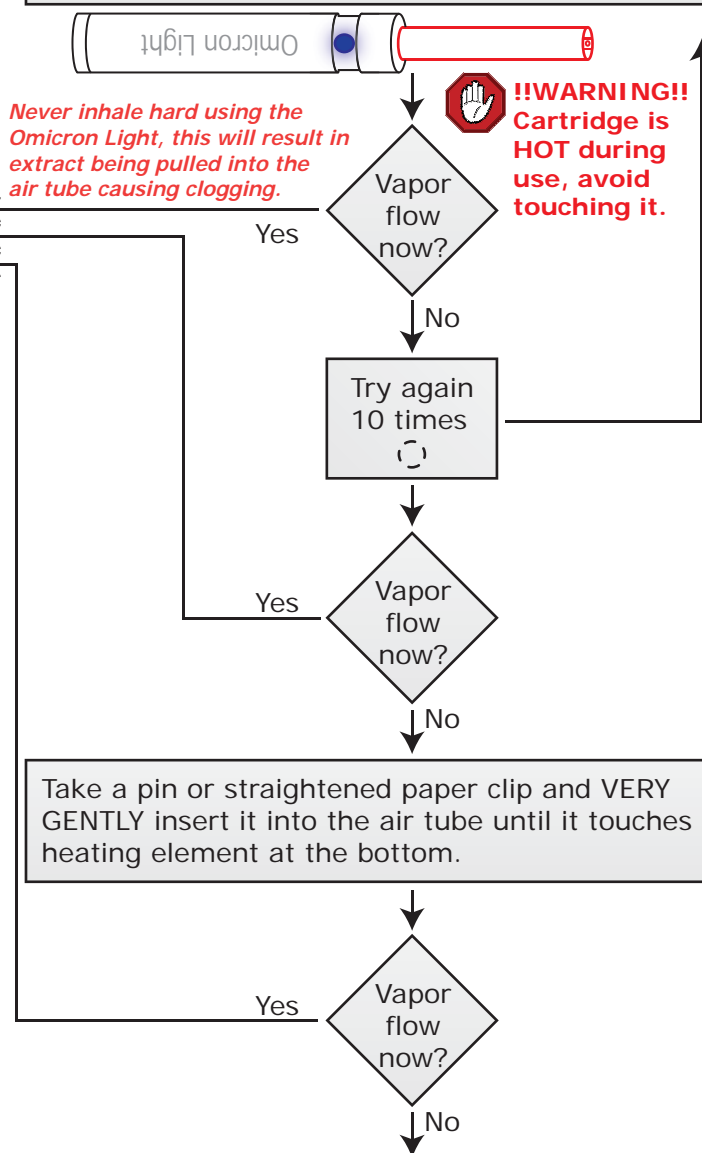

**Never inhale hard using the Omicron Light, this will result in extract being pulled into the air tube causing clogging.**

**!!!WARNING!!! Cartridge is HOT during use, avoid touching it.**



# OMICRON LIGHT USER GUIDE

## MAINTENANCE INSTRUCTIONS

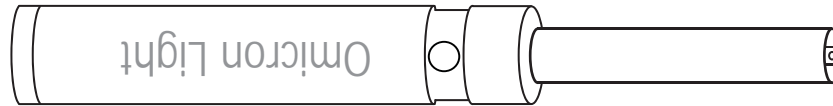

Your Omicron Light Vaporizer has been designed to be easy to care for and maintain.

By following these simple maintenance steps, you will keep your Omicron Light Vaporizer performing at peak performance.

Depending on your frequency of usage, the electrical contact points should be cleaned at least once every 3 - 7 days. The Omicron Light vaporizer uses relatively low voltage to operate and even a small amount of residue on the contact points and/or threads can reduce the voltage flow, impeding the performance of your Omicron Light. **Any residue bridging the gap between the threads and center post on your Omicron Light, could cause a very dangerous electrical short resulting in physical injury to yourself and damage to the battery and/or your Omicron Light Keep It Clean !**

- A.** To clean the electrical contact points and threads, take a cotton swab (Q-Tip) and dip one end into some Isopropyl Alcohol (ISO). The higher percentage of purity, the better, try to use as close to 99% ISO as you can.
- B.** Using the ISO dampened end of the cotton swab, gently scrub and clean any residue from all the contact surfaces and threads on all your **cartridges and Omicron Light**  
The contact surfaces are all the areas that make contact with each other when a cartridge is screwed into the Omicron Light
- C.** Once cleaned, use the dry end of the cotton swab to help the drying process by gently running it over the areas just cleaned. Be careful that no cotton gets left behind on any surfaces or threads.

After every thing is completely dry, lightly touch the contact areas and threads with your fingers. If you feel any tacky areas, please repeat the cleaning procedure steps A - C again until all the contact areas and threads are tack free.

- DO:** Use ISO to clean the contact areas and threads on all your cartridges
- DO:** Use ISO to clean the contact areas and threads on your Omicron Light
- DO:** Keep your Lithium Ion battery in the Omicron Light charged and in good physical condition
- DON'T:** Submerge your cartridge, Omicron Light, USB cable or charger in any liquid
- DON'T:** Try to clean out a cartridge by filling it with ISO
- DON'T:** Leave behind any lint or cotton on the cleaned surfaces or threads
- DON'T:** Screw a cartridge on to the Omicron Light with out cleaning both first
- DON'T:** Use a longer or different USB cable than the one supplied
- AVOID:** Using cartridges that have had their seals damaged and/or thin oil put in them, causing them to leak.





# OMICRON LIGHT USER GUIDE

## FAQ'S

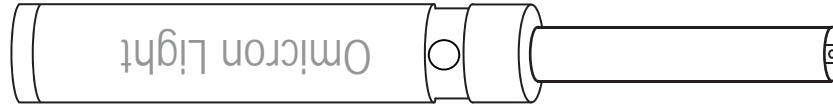

UTOPIA PLANITIA

**Q.** What are the DO's and DON'T's?

- A.** **DO:** Check your Omicron for physical damage such as bent cartridges or damaged buttons before use  
**DO:** Pull air through the cartridge VERY SLOWLY  
**DON'T:** Blow air into the cartridge, you will damage the seals  
**DON'T:** Get any oils, waxes etc. into the air hole during filling  
**DON'T:** Excessively heat below the top 3/4 of the cartridge with a lighter or you will damage the seals  
**DON'T:** Inhale hard, you will suck too much extract into the vaporization chamber causing a clog  
**AVOID:** Extract oils that are too thin or runny at room temperature, or poorly processed / purged

**Q.** Will the Extract cartridges fit other ecig batteries?

- A.** The refillable Pure Extract cartridges were specifically designed for the Omicron, Omicron v2, v2.5, Persei, Omicron Light and O-PHOS only.

**Q.** What types of essential oils can I use?

- A.** Any essential oil that will liquefy with heat and thicken at room temperature that was not produced using water or ice extraction. There can be no plant material left in the extract i.e. earwax, putty, shatter, cO2, nitro etc.

**Q.** Can I remove the white cap?

- A.** We recommend removing the white cap before use and putting it back on after your session if you will be storing the cartridge in a warm area on its side. Otherwise the white cap is not needed.

**Q.** My cartridge is leaking, what can I do?

- A.** The most common reasons for leaking cartridges are:
- Overheating the cartridge with a lighter during filling and the seals are now damaged
  - Blowing air into the cartridge trying to clear a clog, the seals are now damaged
  - Inhaling too hard, try sucking very slowly and lightly
  - Inhaling too soft, try sucking a little harder, but not too hard
  - Over filling the cartridge, 1 gram is the maximum capacity
  - Using oil that is too thin or low quality / poorly processed / purged will leak

If your seals are damaged, it is best to reclaim your extract by turning the cartridge upside down, heating it and collecting the extract that drips out to put into a new cartridge.

**Q.** I hear bubbling sounds when I inhale, is this normal?

- A.** No, bubbling is caused by extract that is too thin at room temperature and/or has impurities in it from not being processed / purged correctly. These extracts are not recommended and will cause your cartridge to clog, leak and generally under perform.

**Q.** My cartridge is defective, what can I do?

- A.** We recommend to test every cartridge before use by connecting it to the Omicron Light **before** filling it with extracts. Our battery/cartridge tester, available separately, is the recommended way to test your Omicron Light and cartridges. You can hold down the power button while looking down the air hole. You should see one of the elements glowing brightly and feel the cartridge getting warm. There are no refunds or exchanges on cartridges for hygienic reasons.



# OMICRON LIGHT USER GUIDE

## FAQ'S

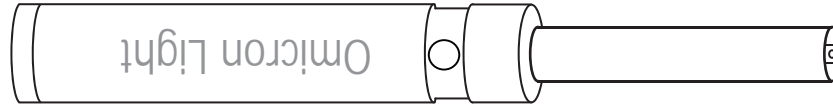

UTOPIA PLANITIA

**Q.** How long does a cartridge last?

**A.** We claim that they will last a minimum of 400 hits or 1 gram of extract. Some users experience a lot more, but 400 is the minimum.

**Q.** How long does the battery last?

**A.** The battery is guaranteed for 14 days and a fully charged battery will last for about 200 6 second hits. Our duration is a conservative figure, based on half of the calculated number. The calculation you can use to estimate your number of hits based on your hit length is:  
*A 3.7 V battery and a 2.4 ohm cart will draw about 1.542 amps of current. ( $I=V/R$ )  
So a 1000 mAh battery will last about 0.65 hr (1.0 amp-hr/1.542 amps) or about 39 minutes of use.*  
6 second hits = 390 hits  
5 second hits = 468 hits  
4 second hits = 585 hits

**Q.** How long does the battery take to charge?

**A.** The answer to this depends on the remaining charge still left in your battery and which battery type you are charging. For an empty battery to fully charge requires approx. 3.5 hours. When in charging mode, the light on the Omicron Light base will be solid **Red** and once charging has completed the light will turn off.

**Q.** My blue light flashes as soon as I press the button, what is causing this?

**A.** If the blue light flashes as soon as you press the button, that is either the low battery warning signal or a short condition somewhere. If your battery is depleted, charge your Omicron Light immediately and fully charge it before using it again. If the blue light continues to flash with a fully charged battery, please contact support.

**Q.** How long is the warranty on the Omicron Light?

**A.** The Omicron Light has a one year Warranty against manufacturer defects. The charger is guaranteed for 30 days and batteries for 14 days. Your invoice from an authorized dealer is needed for any warranty claims.

**Any Omicron Light's bought from an auction site such as eBay, have no warranty.**